

# FP-610

## AMD® Ryzen™ Mobile/Embedded Series Processor based Mini ITX with 4 DisplayPorts



### Features

- CPU: AMD Ryzen™ Mobile/Embedded Series Processor
- Memory: Dual channel SO-DIMM DDR4 up to 64 GB
- Display: AMD Radeon™ Graphics, Up to 4 independent 4K displays
- Ethernet: 10/100/1000Mbps
- Storage: 1xSATA3.0, 2xM.2 for SSD
- Expansion: PCIe 4X, M.2 for WiFi
- Power: 19V DC input



## Introduction

The Maxtang FP610 mini-ITX embedded motherboard is based on the AMD Ryzen™ mobile and embedded series processor, built on the groundbreaking “Zen 2” x86 and “Zen 3” core architecture with innovative 7nm process technology and optimized high-performance Radeon™ graphics in an SoC design. The processor provides unprecedented performance levels, significant design enhancements, and incredible power efficiency for embedded solutions.

The board supports 2xSO-DIMM DDR4 up to 64GB, 4xDP1.4 for four 4K independent displays, 2xM.2 for storage, additional M.2 for Wi-Fi, and optional TPM for added security. Rich I/O interface includes 6xCOM, 8x USB, LPT, GPIO, Line-out, and Mic-in to cater to various applications. It is ideal for applications requiring a high-speed communication front-end mini-server and high-resolution display products like electronic gaming machines, medical imaging, interactive digital signage, thin clients, or PDS terminals.



H/W Monitor



Watchdog



GPIO



Brightness

## I/O Interfaces

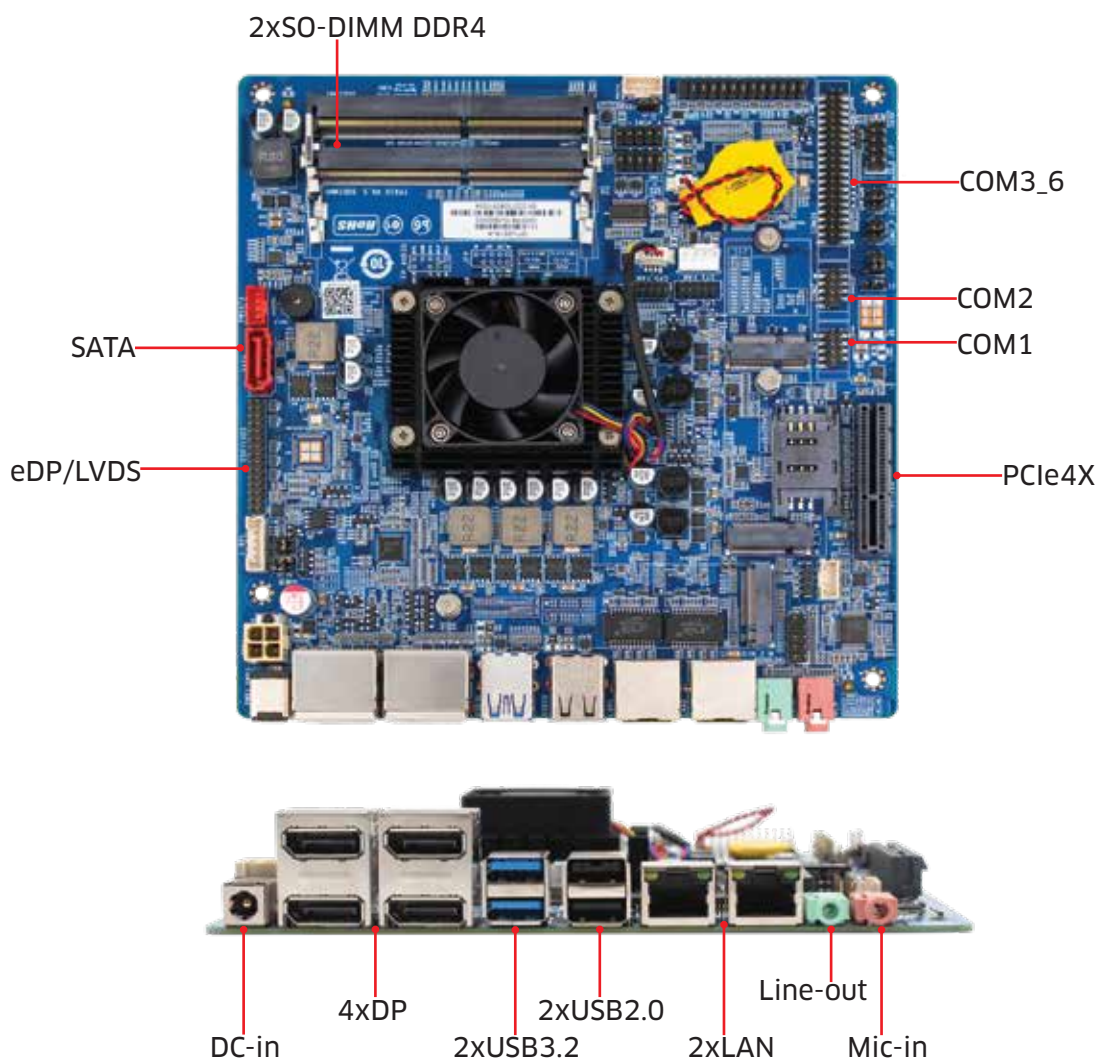

## Technical Specifications

Processor	CPU	V2516	5600H	5800H	
	Cores/Threads	6C/12T	6C/12T	8C/16T	
	Max Boost Frequency	3.95 GHz	4.2 GHz	4.4 GHz	
	Base Frequency	2.1 GHz	3.3 GHz	3.2 GHz	
	L2 / L3 Cache	2MB/8MB	3MB/16MB	4MB/16MB	
	BIOS	AMI SPI BIOS			
Memory	Type	Dual Channel SO-DIMM DDR4			
	Max. Capacity	64GB			
Display	GPU	AMD Radeon™ Graphics			
	Display via	Up to 4 x DP1.4 (DP1/LVDS/eDP Optional)			
	Max Resolution	Resolution up to 4096x2160 for single display			
Ethernet	Speed	10/100/1000 Mbps			
	Controller	RTL8111H			
	Interface	2xRJ 45			
Audio	Audio codec	Realtek HD (1xLine-out, 1xMic-in)			
	Interface	Line-out, Mic-in, support audio header, amplifier header			
Hardware	CPU system temperature, onboard voltage, watchdog				
Wireless connectivity	M.2	1xM.2_E for Wi-Fi and Bluetooth			
Storage	M.2	1xM.2_S/W for 2280/2242 SATA SSD or 4G Module			
		1xM.2_N/S for 2280 NVMe/SATA SSD			
	SATA3.0	1			
Expansion	PCIe 4X	1			
I/O Interface	LAN	2			
	COM	6×RS232 (COM2 can be set as RS485 by jumper)			
	USB3.2	2			
	USB2.0	6 (2*Port + 4*header)			
	Audio	1 x Line-out + 1 x Mic-in			
	GPIO	8 (one group)			
	LPT	1			
	TPM2.0	Onboard, Optional			
	Dimension	Board Type	Mini ITX		
		Size	170 mm x 170 mm		
Power	Standard Port	19V DC-in			
	Peripheral Input	For Fan and SATA			
Temperature	Operating Temp.	-20°C ~60°C			
	Storage Temp.	-20°C ~80°C			
Operating System	Windows 10/11 64bit, Linux 64bit				

\* All specifications and photos are subject to change without notice.

## Functional Block Diagram

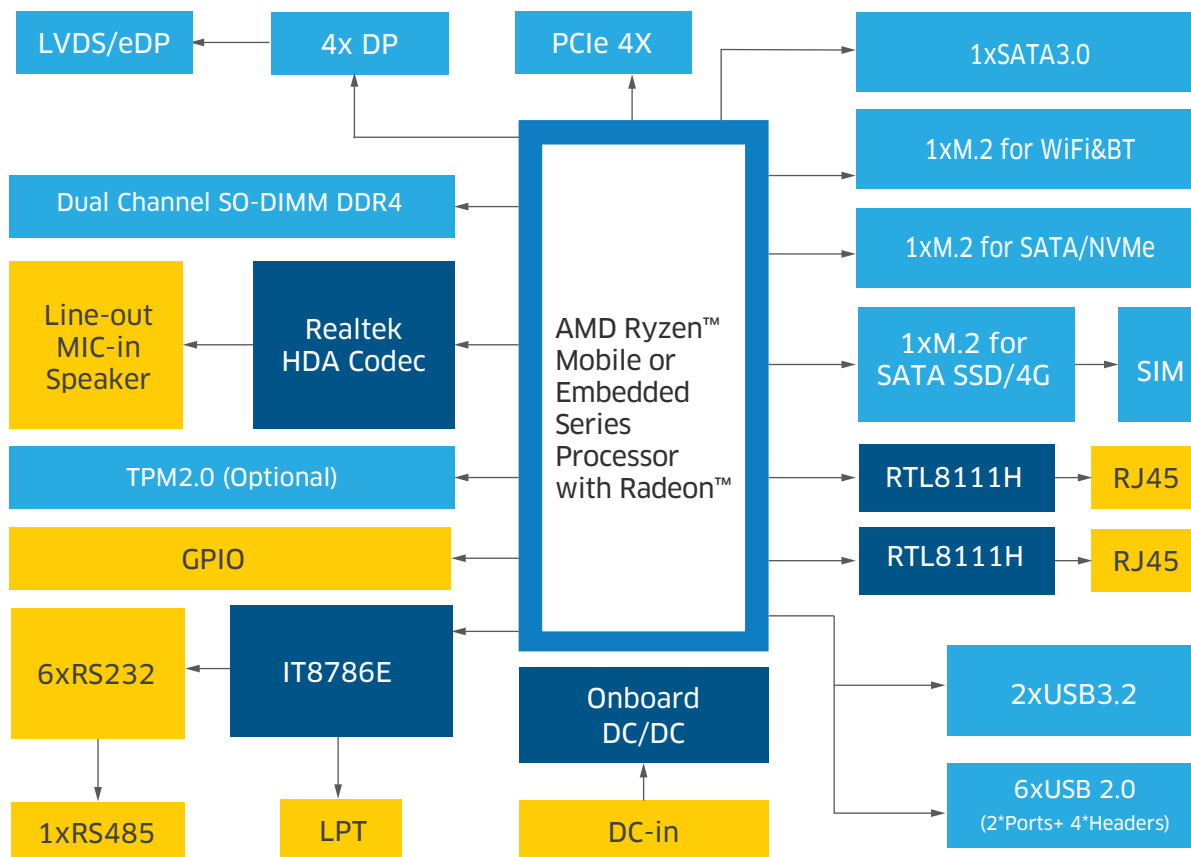

## Order Information

Model Name	Description
DTV2516-A	DT AMD V2516 FP610 2LAN 4DP 6COM
DTV2516-L	DT AMD V2516 FP610 2LAN 3DP+LVDS 6COM
DTV2516-E	DT AMD V2516 FP610 2LAN 3DP+EDP 6COM
DT5600H-A	DT AMD 5600H FP610 2LAN 4DP 6COM
DT5800H-A	DT AMD 5800H FP610 2LAN 4DP 6COM

\*For customized options, please consult regional sales. And please confirm the model name and description before purchasing. \*The model name and description might vary due to inventory changes.

Copyright © 2023 Maxtang Technology Co. Ltd. All rights reserved. All data is for information purposes only and not guaranteed for legal purposes. Information has been carefully checked and is believed to be accurate however, no responsibility is assumed for inaccuracies. Maxtang and the Maxtang logo and all other trademarks or registered trademarks are the property of their respective owners and are recognized.